

New!

Model 53861

4-Channel 200 MHz A/D with DDCs and Kintex UltraScale FPGA - 3U VPX



Model 53861 COTS (left) and rugged version



Features

- Complete radar and software radio interface solution
- Supports Xilinx Kintex UltraScale FPGAs
- Four 200 MHz 16-bit A/Ds
- Four multiband DDCs
- Optional 5 GB of DDR4 SDRAM
- Sample clock synchronization to an external system reference
- LVPECL clock/sync bus for multiboard synchronization
- PCI Express (Gen. 1, 2 & 3) interface up to x8
- Optional LVDS connections to the FPGA for custom I/O
- Compatible with several VITA standards including: VITA-46, VITA-48 and VITA-65 (OpenVPX™ System Specification)
- Ruggedized and conduction-cooled versions available

General Information

Model 53861 is a member of the Jade™ family of high-performance VPX boards. The Jade architecture embodies a new streamlined approach to FPGA-based boards, simplifying the design to reduce power and cost, while still providing some of the highest-performance FPGA resources available today. Designed to work with Pentek's new Navigator™ Design Suite of tools, the combination of Jade and Navigator offers users an efficient path to developing and deploying FPGA-based data acquisition and processing.

The 53861 is a multichannel, high-speed data converter with programmable DDCs (digital downconverters). It is suitable for connection to HF or IF ports of a communications or radar system. Its built-in data capture feature offers an ideal turnkey solution as well as a platform for developing and deploying custom FPGA-processing IP.

It includes four A/Ds, a complete multiboard clock and sync section and the option for a large DDR4 memory. In addition to supporting PCI Express Gen. 3 as a native interface, the Model 53861 includes optional high-bandwidth connections to the Kintex UltraScale FPGA for custom digital I/O.

The Jade Architecture

Evolved from the proven designs of the Pentek Cobalt and Onyx families, Jade raises the processing performance with the new flagship family of Kintex UltraScale FPGAs from Xilinx. As the central feature of the board architecture, the FPGA has access to all data and control paths, enabling factory-installed functions including data multiplexing, channel selection, data packing, gating,

triggering and memory control. The Jade architecture organizes the FPGA as a container for data-processing applications where each function exists as an intellectual property (IP) module.

Each member of the Jade family is delivered with factory-installed applications ideally matched to the board's analog interfaces. The 53861 factory-installed functions include four A/D acquisition IP modules for simplifying data capture and transfer.

Each of the four acquisition IP modules contains a powerful, programmable DDC IP core; an IP module for DDR4 SDRAM memory; a controller for all data clocking and synchronization functions; a test signal generator; and a PCIe interface. These complete the factory-installed functions and enable the 53861 to operate as a complete turnkey solution for many applications, thereby saving the cost and time of custom IP development.

Extendable IP Design

For applications that require specialized functions, users can install their own custom IP for data processing. Pentek Navigator FPGA Design Kits include all of the factory-installed modules as documented source code. Developers can integrate their own IP with the Pentek factory-installed functions or use the Navigator kit to completely replace the Pentek IP with their own.

Xilinx Kintex UltraScale FPGA

The Kintex UltraScale FPGA site can be populated with a range of FPGAs to match the specific requirements of the processing task, spanning the KU035 through ➤

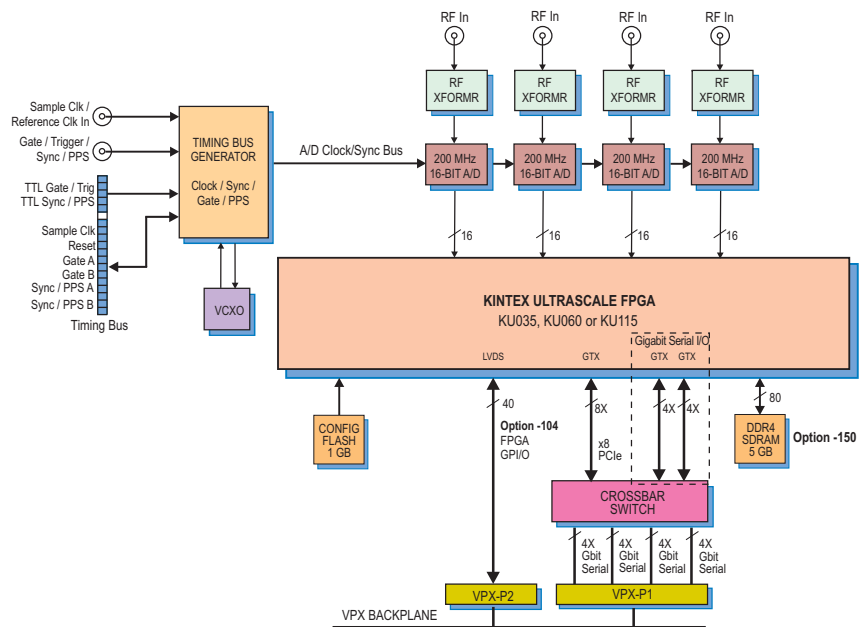

A/D Acquisition IP Modules

The 53861 features four A/D Acquisition IP Modules for easily capturing and moving data. Each IP module can receive data from any of the four A/Ds or a test signal generator

Each IP module has an associated DMA engine for easily moving A/D data through the PCIe interface. These powerful linked-list DMA engines are capable of a unique Acquisition Gate Driven mode. In this mode, the length of a transfer performed by a link definition need not be known prior to data acquisition; rather, it is governed by the length of the acquisition gate. This is extremely useful in applications where an external gate drives acquisition and the exact length of that gate is not known or is likely to vary.

For each transfer, the DMA engine can automatically construct metadata packets containing A/D channel ID, a sample-accurate time stamp and data length information. These actions simplify the host processor’s job of identifying and executing on the data.

DDC IP Cores

Within each A/D Acquisition IP Module is a powerful DDC IP core. Because of the flexible input routing of the A/D Acquisition IP Modules, many different configurations can be achieved including one A/D driving all four DDCs or each of the four A/Ds driving its own DDC.

Each DDC has an independent 32-bit tuning frequency setting that ranges from DC to f_s , where f_s is the A/D sampling frequency. Each DDC can have its own unique decimation setting, supporting as many as four different output bandwidths for the board. Decimations can be programmed from 2 to 32,768 providing a wide range to satisfy most applications.

The decimating filter for each DDC accepts a unique set of user-supplied 24-bit coefficients. The 80% default filters deliver an output bandwidth of $0.8 * f_s / N$,

where N is the decimation setting. The rejection of adjacent-band components within the 80% output bandwidth is better than 100 dB. Each DDC delivers a complex output stream consisting of 24-bit I + 24-bit Q or 16-bit I + 16-bit Q samples at a rate of f_s / N .

► **KU115.** The KU115 features 5520 DSP48E2 slices and is ideal for modulation/demodulation, encoding/decoding, encryption/decryption, and channelization of the signals between transmission and reception. For applications not requiring large DSP resources or logic, a lower-cost FPGA can be installed.

Option -104 provides 20 pairs of LVDS connections between the FPGA and the VPX P2 connector for custom I/O.

A/D Converter Stage

The front end accepts four analog HF or IF inputs on front panel SSMC connectors with transformer coupling into four TI ADS5485 200 MHz, 16-bit A/D converters.

The digital outputs are delivered into the Kintex UltraScale FPGA for signal-processing or routing to other board resources.

Clocking and Synchronization

An internal timing bus provides all timing and synchronization required by the A/D converters. It includes a clock, two sync and two gate or trigger signals. An on-board clock generator receives an external sample clock from the front panel SSMC connector. This clock can be used directly

by the A/D or divided by a built-in clock synthesizer circuit.

In an alternate mode, the sample clock can be sourced from an on-board programmable voltage-controlled crystal oscillator. In this mode, the front panel SSMC connector can be used to provide a 10 MHz reference clock for synchronizing the internal oscillator.

A front panel 26-pin LVPECL Clock/Sync connector allows multiple boards to be synchronized. In the slave mode, it accepts LVPECL inputs that drive the clock, sync and gate signals. In the master mode, the LVPECL bus can drive the timing signals for synchronizing multiple boards.

Multiple boards can be driven from the LVPECL bus master, supporting synchronous sampling and sync functions across all connected boards.

Memory Resources

The 53861 architecture supports an optional 5 GB bank of DDR4 SDRAM memory. User-installed IP along with the Pentek-supplied DDR4 controller core within the FPGA can take advantage of the memory for custom applications.

PCI Express Interface

The Model 53861 includes an industry-standard interface fully compliant with PCI Express Gen. 1, 2 and 3 bus specifications. Supporting PCIe links up to x8, the interface includes multiple DMA controllers for efficient transfers to and from the board. ►

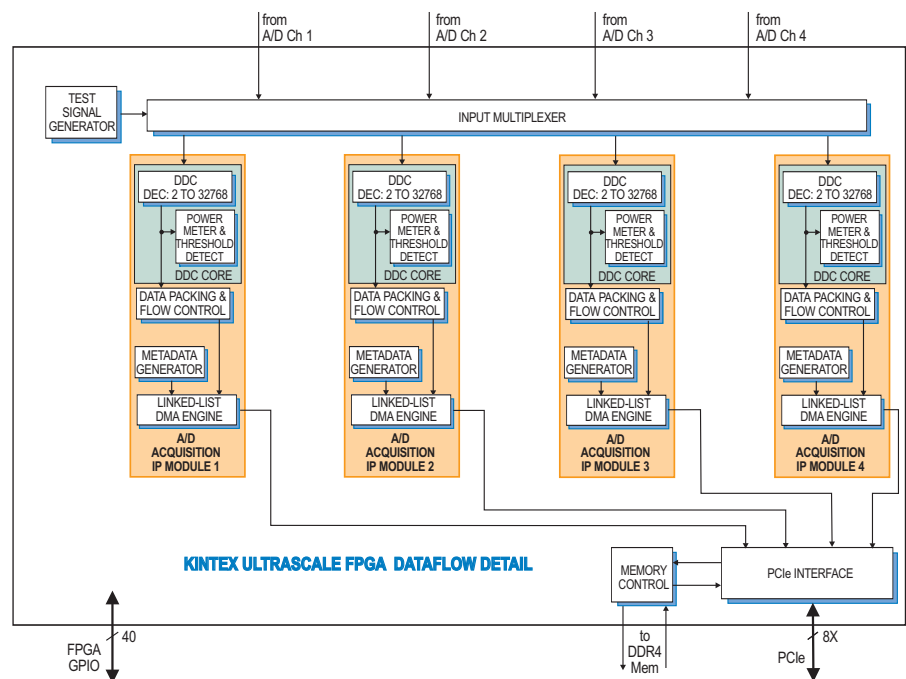

SPARK Development Systems

The SPARK Development Systems are fully-integrated platforms for Pentek Cobalt, Onyx, Jade and Flexor boards. Available in a PC rackmount (Model 8266), a 3U VPX chassis (Model 8267) or a 6U VPX chassis (Model 8264), they were created to save engineers and system integrators the time and expense associated with building and testing a development system. Each SPARK system is delivered with the Pentek board(s) and required software installed and equipped with sufficient cooling and power to ensure optimum performance.



Ordering Information

Model	Description
53861	4-Channel 200 MHz A/D with DDCs and Kintex UltraScale FPGA - 3U VPX

Options:

- 084	XCKU060-2 FPGA
- 087	XCKU115-2 FPGA
-104	LVDS FPGA I/O to VPX P2
- 150	5 GB DDR4 SDRAM
- 702	Air cooled, Level L2
- 713	Conduction cooled, Level L3

Contact Pentek for complete specifications of rugged and conduction-cooled versions

Fabric-Transparent Crossbar Switch

The 53861 features a unique high-speed switching configuration. A fabric-transparent crossbar switch bridges numerous interfaces and components on the board using gigabit serial data paths with no latency. Data paths can be selected as single (1X) lanes, or groups of four lanes (4X).

Specifications

Front Panel Analog Signal Inputs

- Input Type:** Transformer-coupled, front panel female SSMC connectors
- Transformer Type:** Coil Craft WBC4-6TLB
- Full Scale Input:** +8 dBm into 50 ohms
- 3 dB Passband:** 300 kHz to 700 MHz

A/D Converters

- Type:** Texas Instruments ADS5485
- Sampling Rate:** 10 MHz to 200 MHz
- Resolution:** 16 bits

Digital Downconverters

- Quantity:** Four channels
- Decimation Range:** 2x to 32,768x in three stages of 2x to 32x
- LO Tuning Freq. Resolution:** 32 bits, 0 to f_s
- LO SFDR:** >120 dB

- Phase Offset Resolution:** 32 bits, 0 to 360 degrees

- FIR Filter:** 24-bit coefficients, 24-bit output, user-programmable coefficients
- Default Filter Set:** 80% bandwidth, <0.3 dB passband ripple, >100 dB stopband attenuation

Sample Clock Sources: On-board clock synthesizer

Clock Synthesizer

- Clock Source:** Selectable from on-board programmable VCXO (10 to 810 MHz), front panel external clock or LVPECL timing bus

- Synchronization:** VCXO can be locked to an external 4 to 180 MHz PLL system reference, typically 10 MHz

- Clock Dividers:** External clock or VCXO can be divided by 1, 2, 4, 8, or 16 for the A/D clock

External Clock

- Type:** Front panel female SSMC connector, sine wave, 0 to +10 dBm, AC-coupled, 50 ohms, accepts 10 to 800 MHz divider input clock or PLL system reference

Timing Bus: 26-pin connector LVPECL bus includes, clock/sync/gate/PPS inputs and outputs; TTL signal for gate/trigger and sync/PPS inputs

External Trigger Input

- Type:** Front panel female SSMC connector, LVTTTL

- Function:** Programmable functions include: trigger, gate, sync and PPS

Field Programmable Gate Array

Standard: Xilinx Kintex UltraScale XCKU035-2

Option -084: Xilinx Kintex UltraScale XCKU060-2

Option -087: Xilinx Kintex UltraScale XCKU115-2

Custom I/O

Option -104 provides 20 pairs of LVDS connections between the FPGA and the VPX P2 connector for custom I/O.

Memory (Option 150)

Type: DDR4 SDRAM

Size: 5 GB

Speed: 1200 MHz (2400 MHz DDR)

PCI-Express Interface

PCI Express Bus: Gen. 1, 2 or 3: x4 or x8

Environmental

Standard: L0 (air cooled)

Operating Temp: 0° to 50° C

Storage Temp: -20° to 90° C

Relative Humidity: 0 to 95%, non-cond.

Option -702: L2 (air cooled)

Operating Temp: -20° to 65° C

Storage Temp: -40° to 100° C

Relative Humidity: 0 to 95%, non-condensing

Option -713: L3 (conduction cooled)

Operating Temp: -40° to 70° C

Storage Temp: -50° to 100° C

Relative Humidity: 0 to 95%, non-condensing

Size: 3.937 in. x 6.717 in. (100 mm x 170.6 mm)

VPX Families

Pentek offers two families of 3U VPX products: the 52xxx and the 53xxx. For more information on a 53xxx product, please refer to the product datasheet. The table below provides a comparison of their main features.

	VPX Family Comparison	
	52xxx	53xxx
Form Factor	3U VPX	
# of XMCs	One XMC	
Crossbar Switch	No	Yes
PCIe path	VPX P1	VPX P1 or P2
PCIe width	x4	x4 or x8
Option -104 path	24 pairs on VPX P2	20 pairs on VPX P2
Option -105 path	Two x4 or one x8 on VPX P1	Two x4 or one x8 on VPX P1 or P2
Lowest Power	Yes	No
Lowest Price	Yes	No

A/D Performance

Spurious Free Dynamic Range

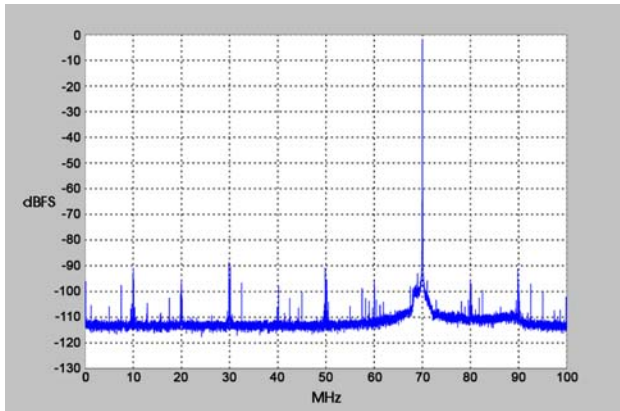

$f_{in} = 70 \text{ MHz}, f_s = 200 \text{ MHz}, \text{Internal Clock}$

Spurious Pick-up

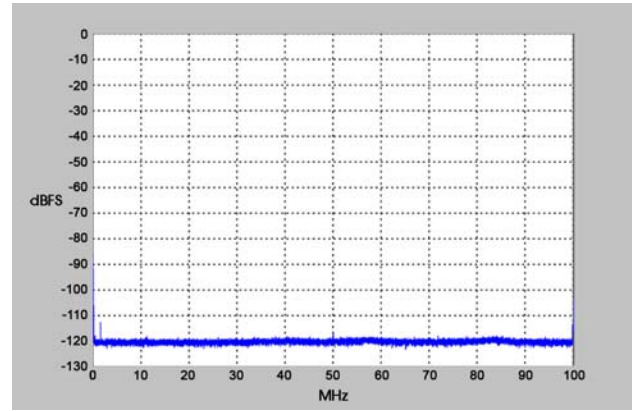

$f_s = 200 \text{ MHz}, \text{Internal Clock}$

Two-Tone SFDR

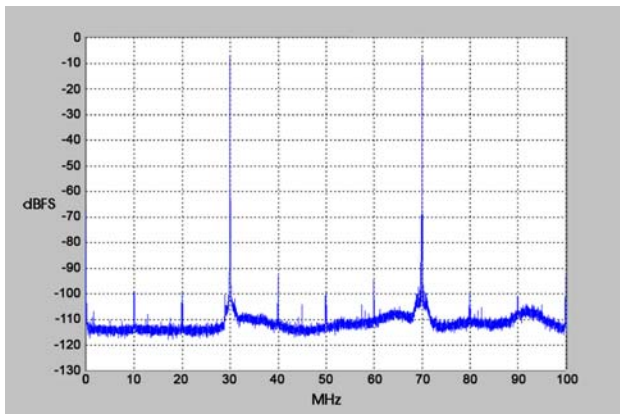

$f_1 = 30 \text{ MHz}, f_2 = 70 \text{ MHz}, f_s = 200 \text{ MHz}$

Two-Tone SFDR

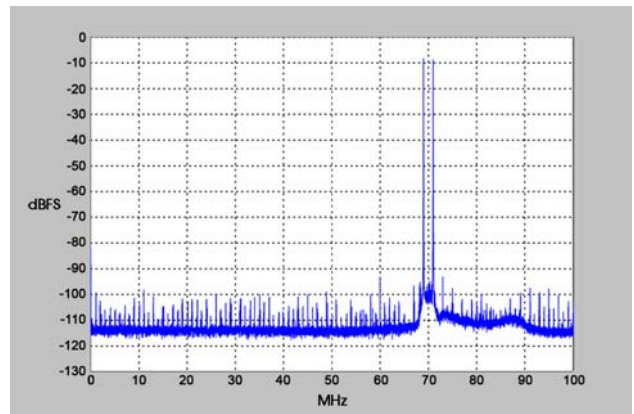

$f_1 = 69 \text{ MHz}, f_2 = 71 \text{ MHz}, f_s = 200 \text{ MHz}$

Adjacent Channel Crosstalk

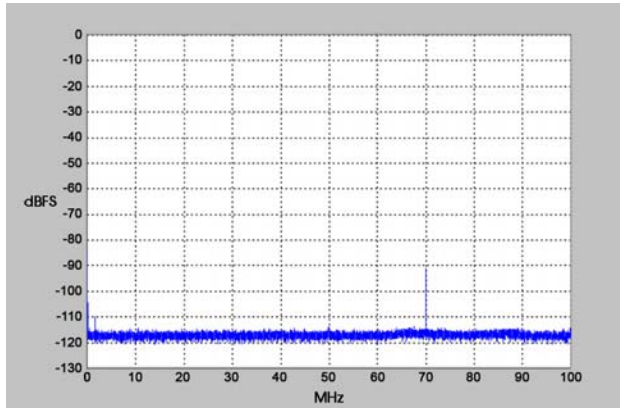

$f_{in \text{ Ch2}} = 70 \text{ MHz}, f_s = 200 \text{ MHz}, \text{Ch 1 shown}$

Input Frequency Response

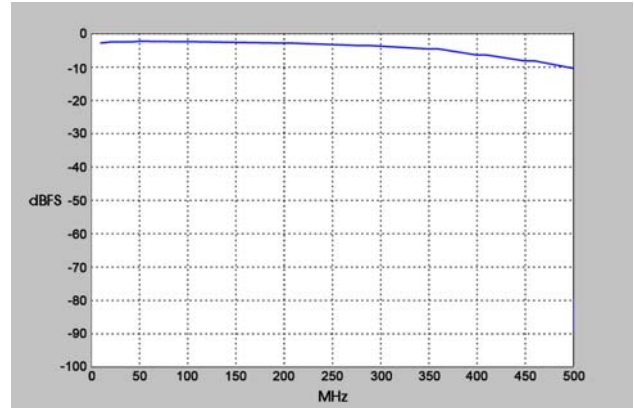

$f_s = 200 \text{ MHz}, \text{Internal Clock}$