

New!

Model RTR 2746

200 MS/sec RF/IF Rugged Rackmount Recorder



Features

- Designed to operate under conditions of shock and vibration
- 4U 19-inch rugged rackmount PC server chassis
- Windows® 7 Professional workstation with high-performance Intel® Core™ i7 processor
- 200 MHz max. 16-bit A/D sampling for recording, up to eight channels
- 80 MHz recording and playback signal bandwidths
- Capable of record/playback of IF frequencies to 700 MHz
- Real-time aggregate recording rates of up to 3.2 GB/sec
- Removable SSD drives
- Up to 46 terabytes of storage to NTFS RAID disk array
- RAID levels of 0 , 1 , 5 , 6 , 10 and 50
- SystemFlow® GUI with signal viewer analysis tool
- C-callable API for integration of recorder into application
- File headers include time stamping and recording parameters
- DDC decimation and DUC interpolation range from 2 to 65,536
- Optional GPS time and position stamping

Contact factory for options, number and type of analog channels, recording rates, and disk capacity.

General Information

The Talon® RTR 2746 is a turnkey, multi-band record and playback system that is built to operate under harsh conditions. Designed to withstand high vibration and operating temperatures, the RTR 2746 is intended for military, airborne and UAV applications requiring a rugged system. With scalable A/Ds, D/As and SSD (Solid-State Drive) storage, the RTR 2746 can be configured to stream data to and from disk at rates as high as 3.2 GB/sec.

The RTR 2746 uses Pentek's high-powered Virtex-6-based Cobalt® boards, that provide flexibility in channel count with optional digital downconversion capabilities. Optional 16-bit, 1.25 GHz D/A converters with digital upconversion allow real-time reproduction of recorded signals.

A/D sampling rates, DDC decimations and bandwidths, D/A sampling rates, and DUC interpolations are among the GUI-selectable system parameters, providing a fully programmable system capable of recording and reproducing a wide range of signals.

Optional GPS time and position stamping allows the user to record this critical signal information.

SystemFlow Software

The RTR 2746 includes the SystemFlow Recording Software. SystemFlow features a Windows-based GUI (Graphical User Interface) that provides a simple means to configure and control the system. Custom configurations can be stored as profiles and later loaded when needed, allowing the user to select preconfigured settings with a single click.

SystemFlow also includes signal viewing and analysis tools, that allow the user to monitor the signal prior to, during, and after a recording session. These tools include a virtual oscilloscope and a virtual spectrum analyzer.

Built on a Windows 7 Professional workstation, the RTR 2746 allows the user to install post-processing and analysis tools to operate on the recorded data. The RTR 2746 records data to the native NTFS file system, providing immediate access to the recorded data.

Data can be off-loaded through two rear-access gigabit Ethernet ports or two USB 2.0 ports. Additionally, data can be copied to optical disk, using the 8X double layer DVD±R/RW drive.

Rugged and Flexible Architecture

Because SSDs operate reliably under conditions of shock and vibration, the RTR 2746 performs well in ground, shipborne and airborne environments. The hot-swappable SSDs provide storage capacity of up to 46 TB. The drives can be easily removed or exchanged during or after a mission to retrieve recorded data.

The RTR 2746 is configured in a 4U 19" rack-mountable chassis, with hot-swap data drives, front panel USB ports and I/O connectors on the rear panel.

Systems are scalable to accommodate multiple chassis to increase channel counts and aggregate data rates.

All recorder chassis are connected via Ethernet and can be controlled from a single GUI either locally or from a remote PC.

Multiple RAID levels, including 0, 1, 5, 6, 10 and 50, provide a choice for the required level of redundancy. ➤

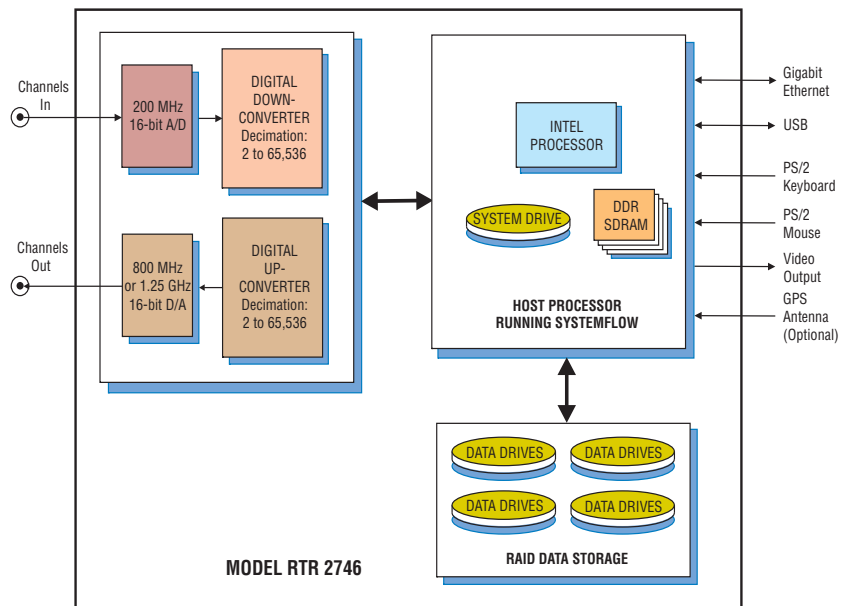

► SystemFlow Graphical User Interface

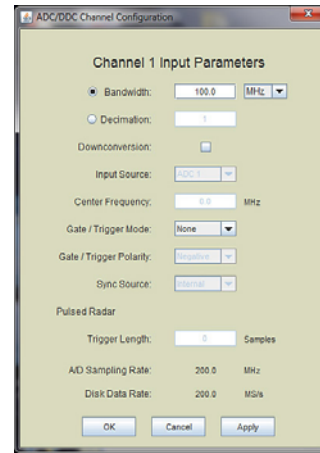
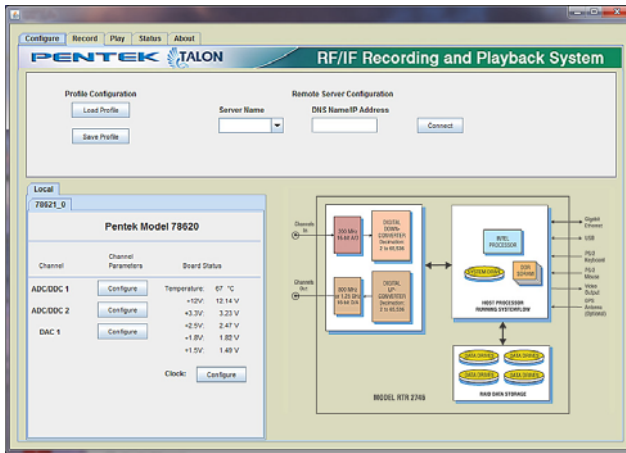

SystemFlow Recorder Interface

The RTR 2746 GUI provides the user with a control interface for the recording system. It includes Configuration, Record, Playback and Status screens, each with intuitive controls and indicators. The user can easily move between screens to set configuration parameters, control and monitor a recording, play back a recorded signal and monitor board temperature and voltage levels. The signal viewer, integrated into the recording GUI, allows the user to monitor real-time signals or signals recorded on disk.

SystemFlow Hardware Configuration Interface

The RTR 2746 Configure screens provide a simple and intuitive means for setting up the system parameters. The DDC configuration screen shown here, allows user entries for input source, center frequency, decimation, as well as gate and trigger information. All parameters contain limit-checking and integrated help to provide an easier-to-use out-of-the-box experience.

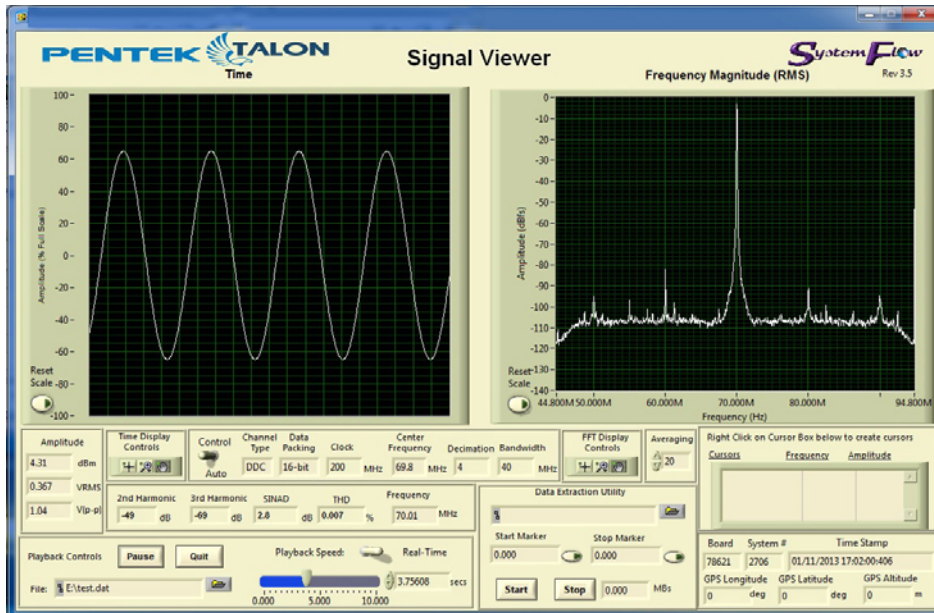

SystemFlow Signal Viewer

The SystemFlow Signal Viewer includes a virtual oscilloscope and spectrum analyzer for signal monitoring in both the time and frequency domains. It is extremely useful for previewing live inputs prior to recording, and for monitoring signals as they are being recorded to help ensure successful recording sessions. The viewer can also be used to inspect and analyze the recorded files after the recording is complete.

Advanced signal analysis capabilities include automatic calculators for signal amplitude and frequency, second and third harmonic components, THD (total harmonic distortion) and SINAD (signal to noise and distortion). With time and frequency zoom, panning modes and dual, annotated cursors to mark and measure points of interest, the SystemFlow Signal Viewer can often eliminate the need for a separate oscilloscope or spectrum analyzer in the field. ►

► A/D Performance

Spurious Free Dynamic Range

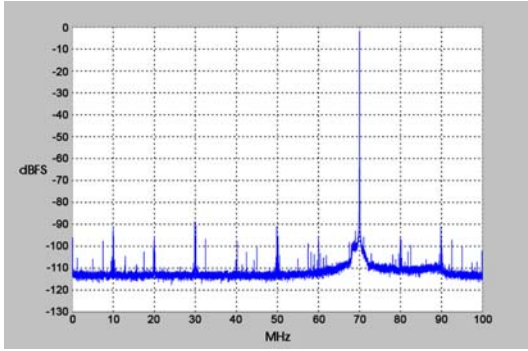

$f_{in} = 70 \text{ MHz}$, $f_s = 200 \text{ MHz}$, Internal Clock

Spurious Pick-up

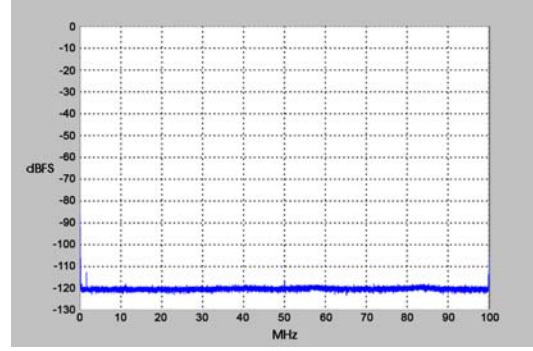

$f_s = 200 \text{ MHz}$, Internal Clock

Two-Tone SFDR

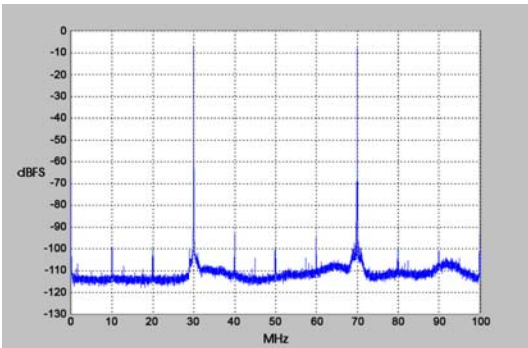

$f_1 = 30 \text{ MHz}$, $f_2 = 70 \text{ MHz}$, $f_s = 200 \text{ MHz}$

Two-Tone SFDR

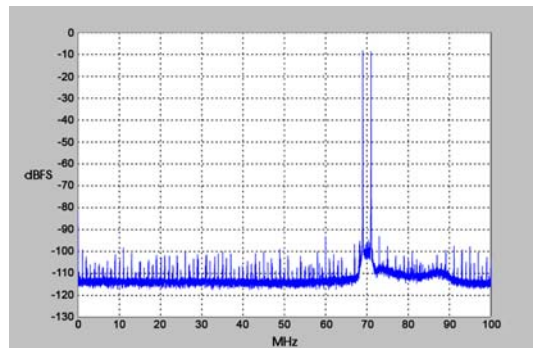

$f_1 = 69 \text{ MHz}$, $f_2 = 71 \text{ MHz}$, $f_s = 200 \text{ MHz}$

Adjacent Channel Crosstalk

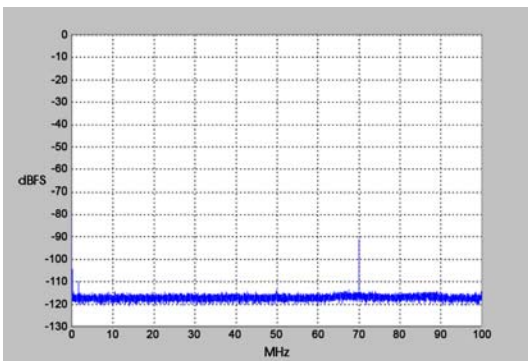

$f_{in \text{ Ch2}} = 70 \text{ MHz}$, $f_s = 200 \text{ MHz}$, Ch 1 shown

Input Frequency Response

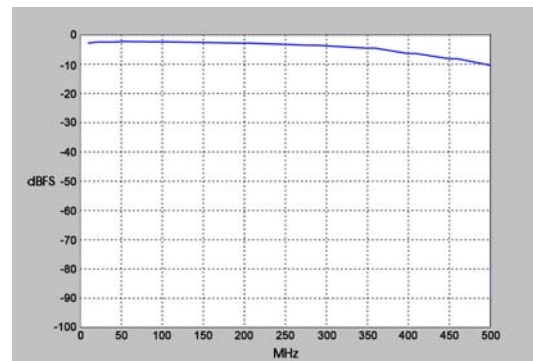

$f_s = 200 \text{ MHz}$, Internal Clock

Spurious Free Dynamic Range

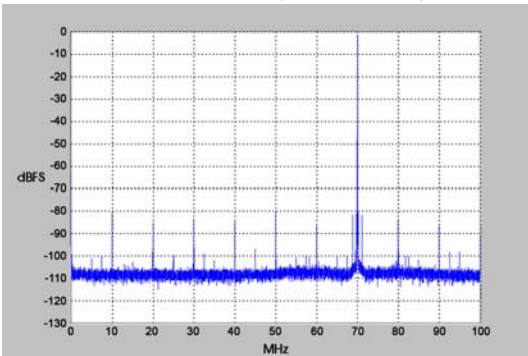

$f_{out} = 70 \text{ MHz}$, $f_s = 200 \text{ MHz}$, Internal Clock

D/A Performance

Spurious Free Dynamic Range

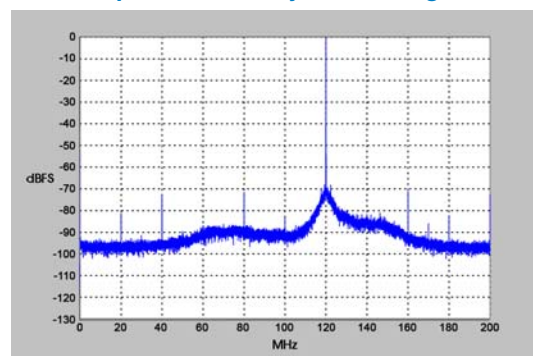

$f_{out} = 120 \text{ MHz}$, $f_s = 400 \text{ MHz}$, External Clock

► Specifications

PC Workstation (standard configuration)

Operating System: Windows7 Professional
Processor: Intel Core i7 processor
Clock Speed: 2.0 GHz or higher
SDRAM: 6 GB
RAID
Storage: 3.8, 7.6, 15.3, 30.7 or 46.0 TB
Supported Levels: 0, 1, 5, 6, 10 and 50

Analog Recording Inputs

Analog Signal Inputs
Input Type: Transformer-coupled, front panel female SSMC connectors
Transformer Type: Coil Craft WBC4-6TLB
Full Scale Input: +8 dBm into 50 ohms
3 dB Passband: 300 kHz to 700 MHz

A/D Converters

Type: Texas Instruments ADS5485
Sampling Rate: 10 MHz to 200 MHz
Resolution: 16 bits
A/D Record Bandwidth: $f_s/2$ = Nyquist bandwidth
Anti-Aliasing Filters: External, user-supplied

Digital Downconverter

Type: Virtex-6 FPGA Pentek DDC IP Core
Decimation (D): 2 to 65,536
IF Center Frequency Tuning: DC to f_s , 32 bits
DDC Usable Bandwidth: $0.4 * f_s / D$

Analog Signal Outputs

Output Type: Transformer-coupled, front panel female SSMC connectors
Full Scale Output: +4 dBm into 50 ohms
3 dB Passband: 300 kHz to 700 MHz

Digital Upconverter and D/As

Type: TI DAC5688 and Pentek-installed interpolation IP core
Interpolation: 2 to 65,536
Input Data Rate: 250 MHz max.
Output IF: DC to 400 MHz
Output Signal: Analog, real or quadrature
Output Sampling Rate: 800 MHz max. with 2, 4 or 8 interpolation
Resolution: 16 bits

Clock Sources: Selectable from onboard programmable VCXO, external or LVDS clocks

External Clocks

Type: Front panel female SSMC connector, sine wave, 0 to +10 dBm, AC-coupled, 50 ohms, 10 to 200 MHz
Multi-Recorder Sync/Gate Bus: 26-pin connector, dual clock/ sync/gate input/output LVDS buses; one sync/gate input TTL signal

Physical and Environmental

Dimensions

4U Short Chassis: 19" W x 21" D x 7" H
Weight: 50 lb, approx.
Operating Temp: 0° to +50° C
Storage Temp: -40° to +85° C
Relative Humidity: 5 to 95%, non-condensing
Operating Shock: 15 g max. (11 msec, half sine wave)
Operating Vibration: 10 to 20 Hz: 0.02 inch peak, 20 to 500 Hz: 1.4 g peak acceleration
Power Requirements: 100 to 240 VAC, 50 to 60 Hz, 500 W max.

Model RTR 2746 Ordering Information and Options

Channel Configurations

Option -201	1-channel recording
Option -202	2-channel recording
Option -203	3-channel recording
Option -204	4-channel recording
Option -208	8-channel recording
Option -221	1-channel playback
Option -222	2-channel playback
Option -224	4-Channel playback
Option -228	8-Channel playback

Storage Options

Option -410	3.8 TB SSD storage capacity	3.2 GB/sec
Option -415	7.6 TB SSD storage capacity	3.2 GB/sec
Option -420	15.3 TB SSD storage capacity	3.2 GB/sec
Option -430	30.7 TB SSD storage capacity	3.2 GB/sec
Option -440	46.0 TB SSD storage capacity	3.2 GB/sec

Note: Options -430 and -440 require a 26-inch deep chassis

Max. Data Rate

General Options (append to all options)

Option -261	GPS time & position stamping
Option -264	IRIG-B time stamping

Contact Pentek for compatible Option combinations
Storage and Channel-count Options may change, contact Pentek for the latest information

Specifications subject to change without notice